



# Accelerate Your Trading Strategies: Introducing the New Alveo™ **X3 Series**

Alastair Richardson  
Strategic Business Development Director, Data  
Center and Communications Group  
AMD

November 30th, 2022



# Introducing the Alveo™ X3 Series Adapters

In Production

Alveo X3 Series

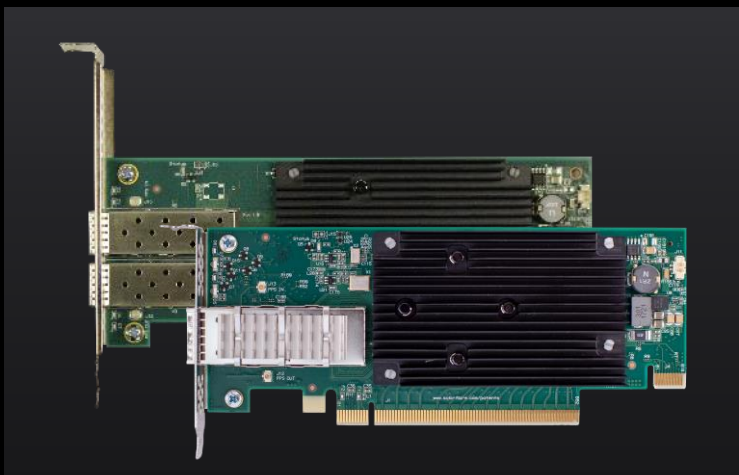

**X2 Series**  
Offload NICs

- X2522 Low Latency NIC  
2x10/25G
- X2541 Low Latency NIC  
1x 10/25/40/50/100G

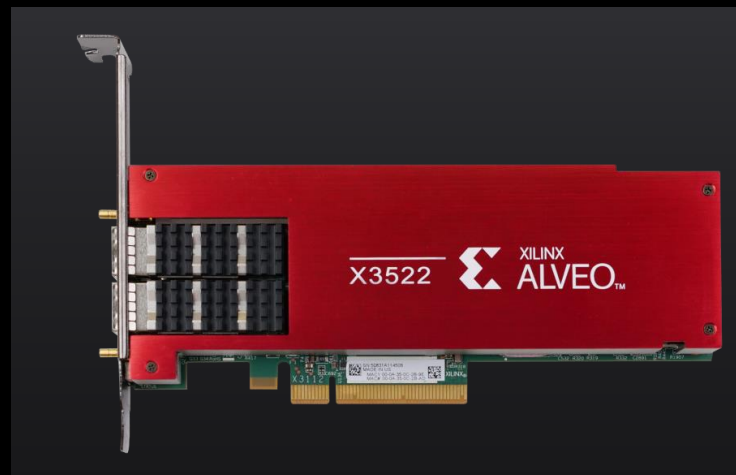

**Alveo X3522**  
Low Latency Network Adapter

- 4x10/25G
- Lower latency
- Improved architecture
- Upgradeable
- Optional upgrade access to 400K LUTs

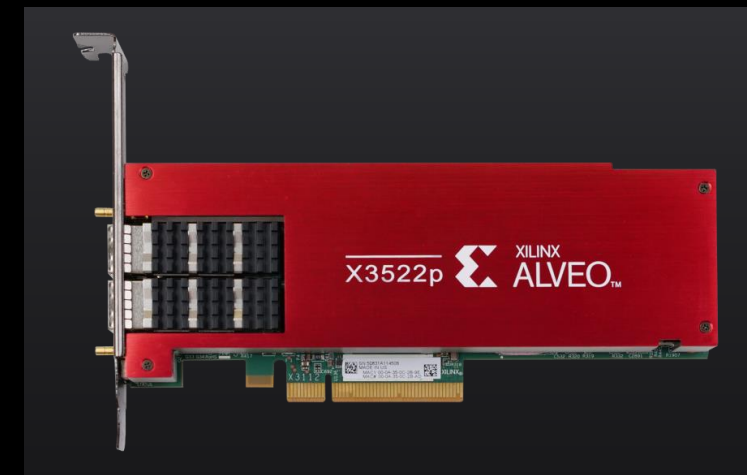

**Alveo X3522PV**  
Accelerator Card

- 2x DSFP connectors
- Time synchronization (PPS In/Out)
- Access to ~1M LUTs
- -3 silicon enables up to 644MHz operation, 16b

# Low Latency NIC Features and Capabilities

## Alveo™ X3522

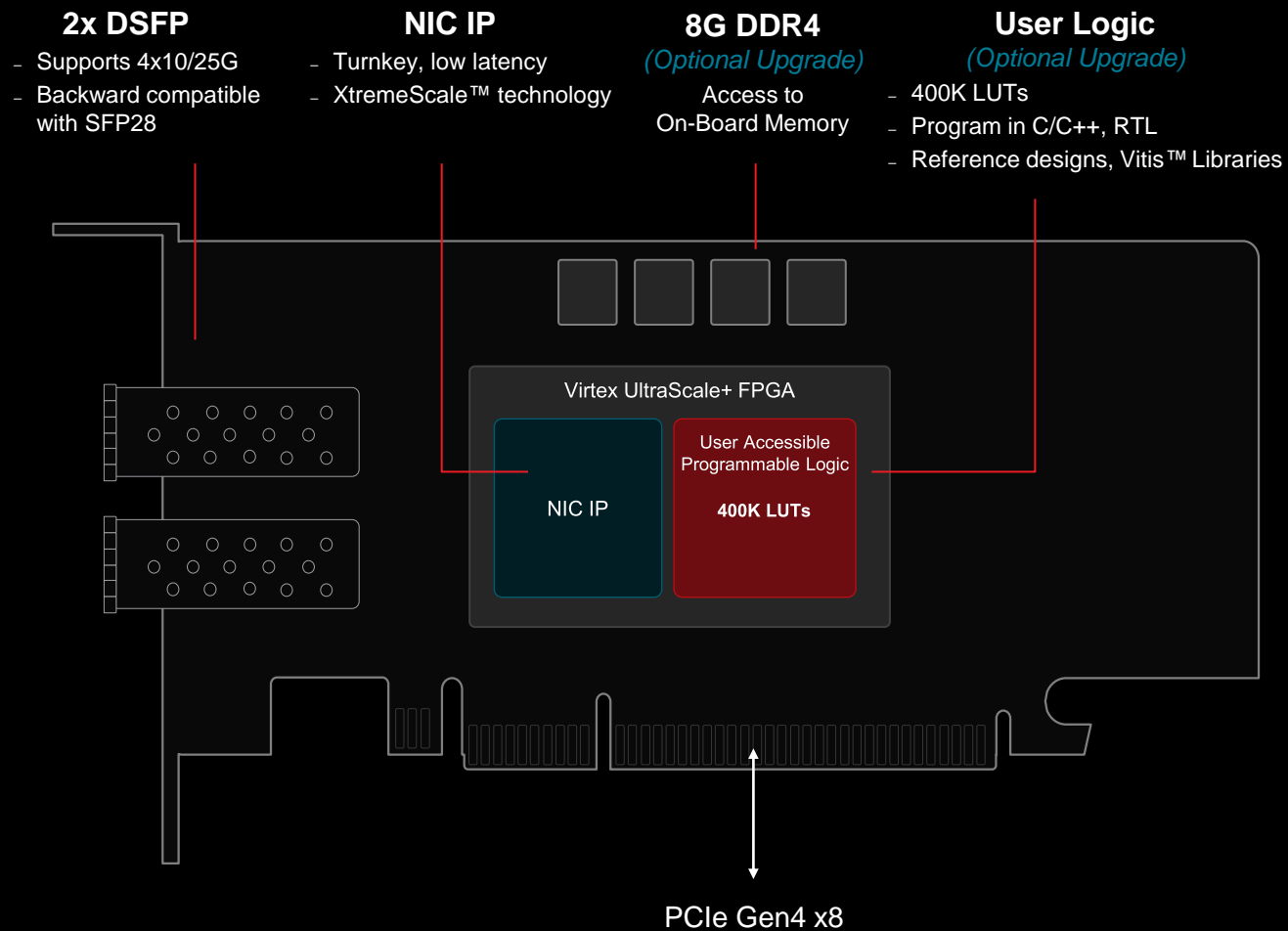

FEATURES	SPECIFICATION
Power	<ul style="list-style-type: none"> <li>• 35W (NIC mode)</li> <li>• Up 75W max power (hybrid mode) (PL dependent)</li> </ul>
User Functional Space	400K LUTs (hybrid upgrade package)
Programmability	<ul style="list-style-type: none"> <li>• C/C++ High-Level Synchess (HLS)</li> <li>• RTL (hardware design)</li> <li>• ULL Framework IP from Orthogone Technologies</li> <li>• ANTS reference design (utilizes Onload®)</li> <li>• Delegated Send</li> </ul>
Memory	8GB DDR4 (hybrid upgrade package)
PCIe® Config	Gen4 x8
Network Port Config	4 x 10GbE/25GbE
1PPS Support	SMA connector, through IO bracket
PTP	Stratum 3 oscillator, PTPv2 support
Software	<ul style="list-style-type: none"> <li>• Vitis® SW Environment (C/C++, libraries)</li> <li>• Onload SW for kernel bypass</li> <li>• TCPDirect</li> <li>• ef_vi API for latency optimization</li> <li>• XRT runtime SW</li> </ul>

# Accelerator Card Features and Capabilities

## Alveo™ X3522PV

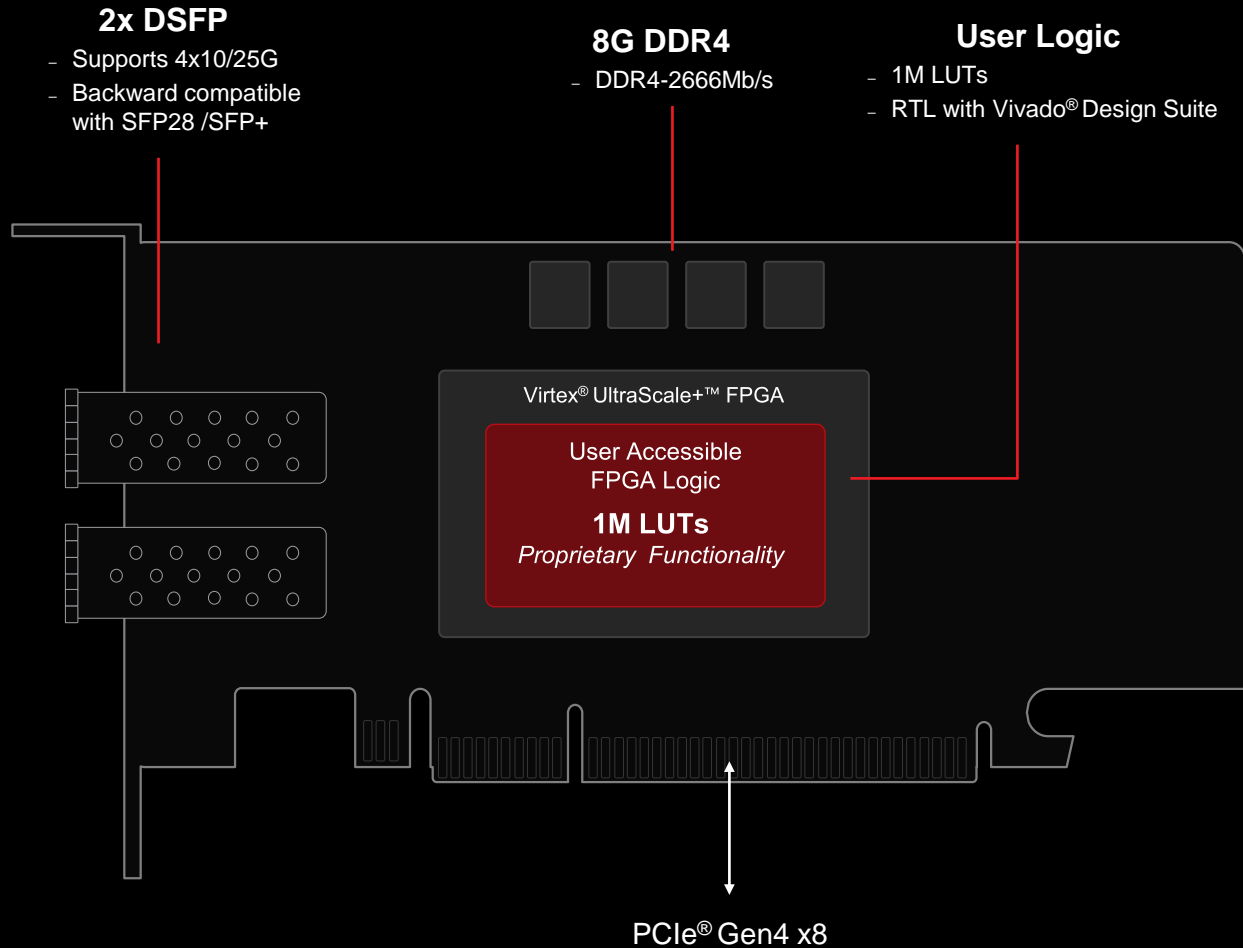

### FEATURES

### SPECIFICATION

Power	75W Max Power
Device	<ul style="list-style-type: none"> <li>• Virtex UltraScale+ XCUX35</li> <li>• -3 speed grade</li> </ul>
SerDes (GTY) Capability	16b, 644MHz operation supported
Programmability	Vivado Design Suite
Memory	8GB DDR4
PCIe Config	Gen4 x8
Network Port Config	4 x 10GbE/25GbE
1PPS Support	SMA connector, through IO bracket
Software	Vivado Design Suite
Sideband Support	PLDM over MCTP over SMBus
LUTs	1,030K
Embedded RAM	<ul style="list-style-type: none"> <li>• 99 Mb UltraRAM</li> <li>• 74.3Mb Block RAM</li> </ul>

# Alveo™ X3 Series Advantages



## Low latency, plug-and-play NIC

High port density (4x 10/25GbE), based on Xtremescale™ NIC technology



## Determinism for reliable trade execution

Reordering, underruns, collisions handled by NIC

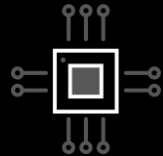

## CPU offload for hybrid trading

Offload business logic to NIC



## HW upgradeable after deployment

Integrate new features from AMD



## Adaptable Acceleration and Customization

Hardware flexibility for custom fintech solutions

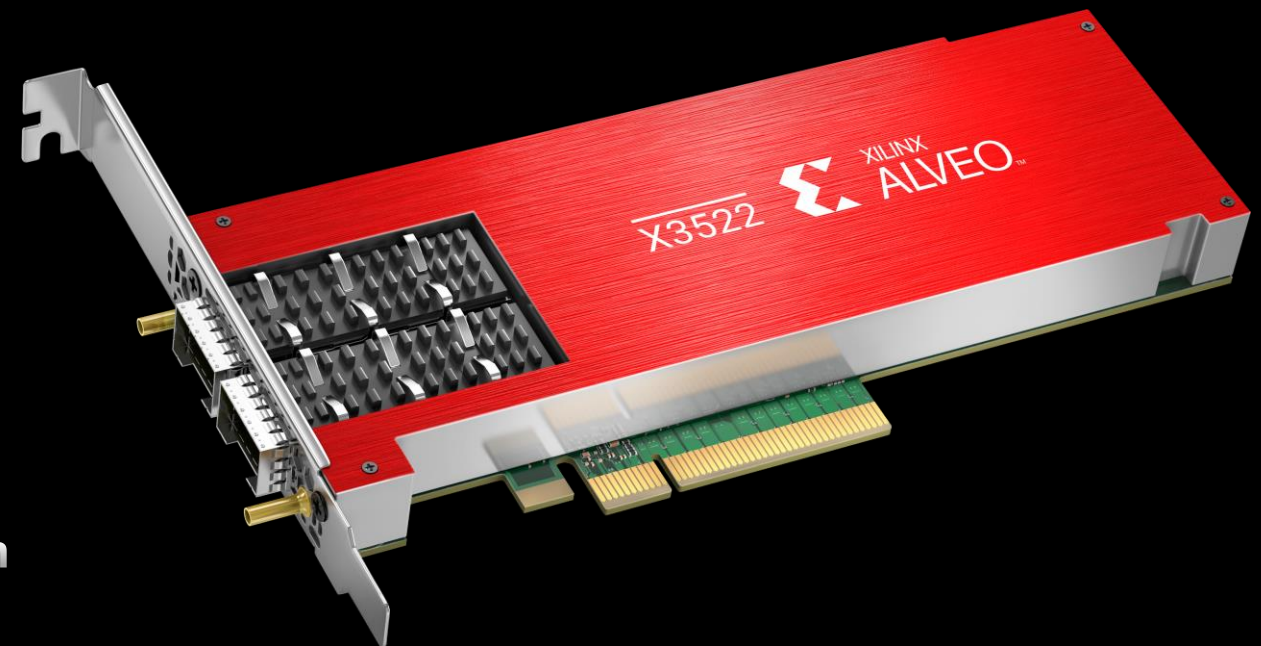

# Get Started Now

## Learn More

[www.xilinx.com/x3](http://www.xilinx.com/x3)

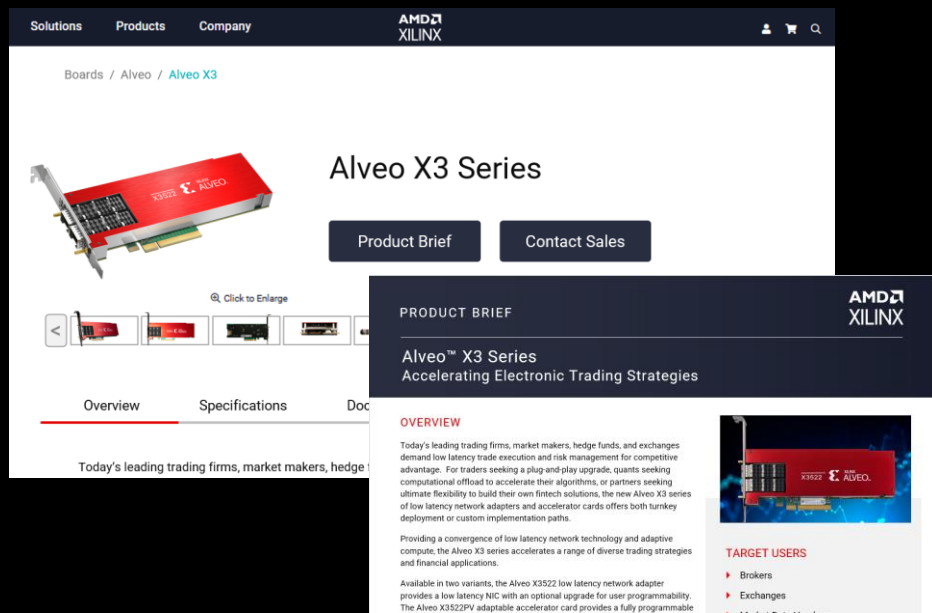

## Order Today

Contact Your Local Sales Representative

<https://www.xilinx.com/about/contact/contact-sales.html>

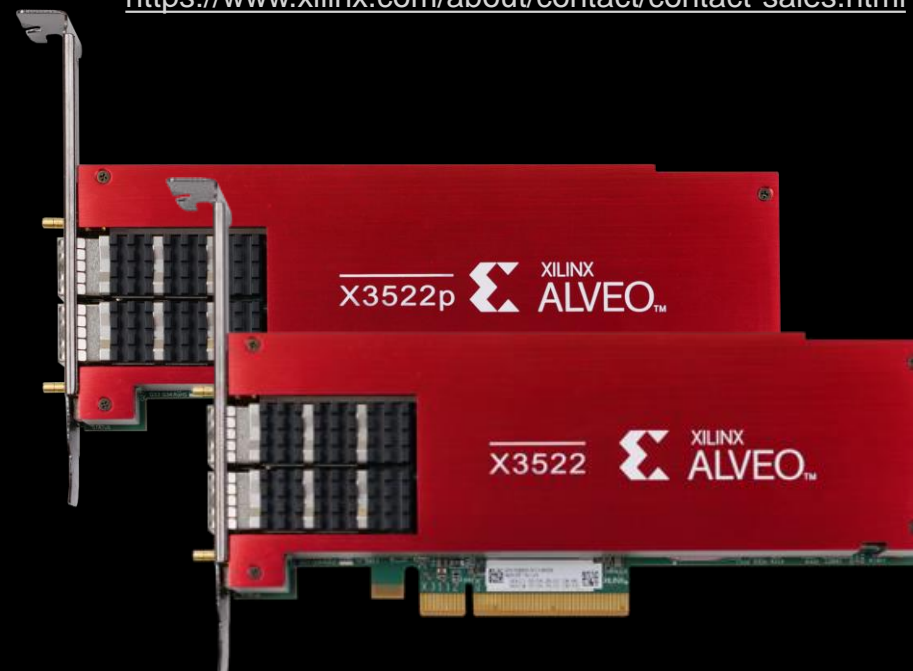

**AMD** 

# Disclaimer & Attribution

Timelines, roadmaps, and/or product release dates shown in these slides are plans only and subject to change.

The information contained herein is for informational purposes only and is subject to change without notice. While every precaution has been taken in the preparation of this document, it may contain technical inaccuracies, omissions and typographical errors, and AMD is under no obligation to update or otherwise correct this. Advanced Micro Devices, Inc. makes no representations or warranties with respect to the accuracy or completeness of the contents of this document, and assumes no liability of any kind, including the implied warranties of noninfringement, merchantability or fitness for particular purposes, with respect to the operation or use of AMD hardware, software or other products described herein. No license, including implied or arising by estoppel, to any intellectual property rights is granted by this document. Terms and limitations applicable to the purchase or use of AMD's products are as set forth in a signed agreement between the parties or in AMD's Standard Terms and Conditions of Sale.

©2022 Advanced Micro Devices, Inc. All rights reserved. AMD, the AMD Arrow logo, Athlon, CDNA, EPYC, Infinity Fabric Radeon, RDNA, ROCm, Ryzen, Ryzen Threadripper, Xilinx, the Xilinx logo, Alveo, Artix, Kintex, Spartan, Versal, Vitis, Virtex, and Zynq and combinations thereof are trademarks of Advanced Micro Devices, Inc. Microsoft is registered trademark of Microsoft Corporation in the US and other jurisdictions. SPEC®, SPECrate®, SPECint and SPEC CPU® are registered trademarks of the Standard Performance Evaluation Corporation. See [www.spec.org](http://www.spec.org) for more information. Other product names used in this publication are for identification purposes only and may be trademarks of their respective companies.

"Zen," "Zen 2," "Zen 3," "Zen 4," "CDNA," "CDNA 2," "Vega," "Polaris," "GCN," "Naples," "Rome," "Milan" and "Genoa" are codenames for AMD architectures and are not product names.